

# 302



## Kugelhähne außen/innen mit PTFE-Stopfbuchspackung und O-Ring Male/female ball valves with PTFE seal and O-ring

**TRINKWASSER**  
DRINKING WATER

**VOLLER DURCHGANG**  
FULL BORE

**PN25**

**MADE IN ITALY**



**AUSSEN  
VERNICKELT**  
EXTERNALLY  
NICKEL-PLATED

Für Sanitär- und Heizungsinstallationen, geeignet für den Trinkwasserverbrauch. Für den Einbau in Mitteldruckanlagen zur Industrie- und Gebäudeheizungsanlagen, sowie pneumatischen Anlagen, mit nicht aggressiven Medien.

For plumbing-heating systems and drinking water consumption. Installation in medium pressure industrial and civil heating systems, pneumatic systems and for non-aggressive fluids.

Betriebsdruck: 25 bar

Betriebstemperatur: -20°C +130°C (kein Frost)

Zylindrische Gewinde nach ISO 228-1

Spindeldichtung:

- 3/8"- Spindel von außen mit PTFE-Stopfbuchspackung montiert und mit Stellmutter verstellbar;

- 1/2" bis 2"- Spindel von innen mit 1 EPDM-PEROX-O-Ring und PTFE-Stopfbuchspackung montiert und mit Stellmutter verstellbar

Kugeldichtung mit 2 PTFE-Kugeldichtungen

Voller Durchgang

Working pressure: 25 bar

Working temperature: -20°C +130°C (no frost)

Cylindrical threads according to ISO 228-1

Seal on stem:

- 3/8" stem assembled from outside with PTFE seal and adjustable packing gland;

- from 1/2" to 2" stem assembled from inside with 1 EPDM PEROX OR, PTFE seal and adjustable packing gland.

Seal on the ball with 2 PTFE gaskets

Full bore

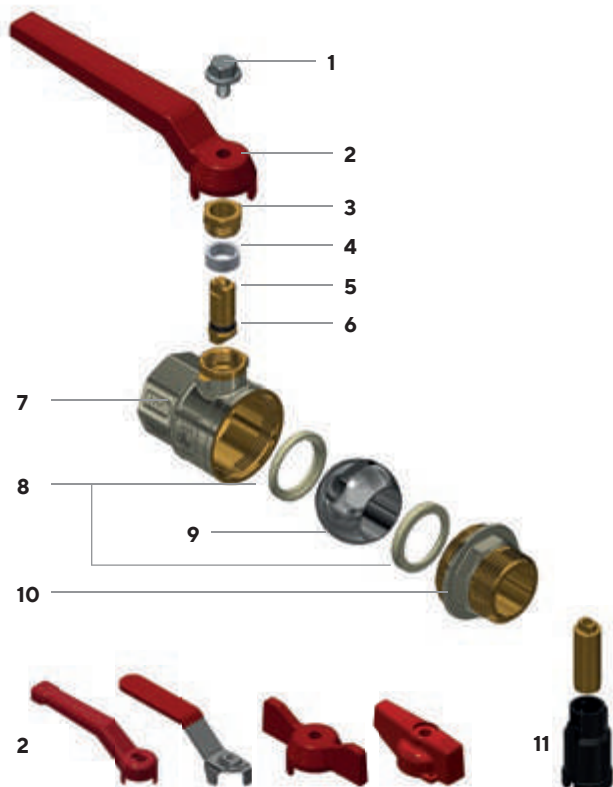

- 1 Schraube aus AISI 430 Stahl oder aus Fe-Zn/Bn je nach Modell
- 2 Verfügbare Hebel: siehe Tabellen unten
- 3 Einstellring aus CW614N UNI EN 12164
- 4 PTFE-Stopfbuchring
- 5 Spindel aus CW614N UNI EN 12164
- 6 O-Ring aus EPDM PEROX
- 7 Körper aus CW617N EN 12165, nur außen vernickelt
- 8 PTFE-Kugeldichtung
- 9 Kugel aus CW617N EN 12165 verchromt
- 10 Muffe aus CW617N EN 12165 nur außen vernickelt
- 11 Für Versionen 1/2" und 3/4", Verlängerungshülse aus Kunststoff PA6, 50% glasfaserverstärkt, für die Ausführungen von 1" bis 2" aus vernickeltem CW617N UNI EN 12165.

- 1 AISI 430 steel or Fe-Zn/Bn screw, depending on model
- 2 Available levers: see following tables
- 3 CW614N UNI EN 12164 packing gland
- 4 PTFE ring seal
- 5 CW614N UNI EN 12164 stem
- 6 O-Ring aus EPDM PEROX
- 7 CW617N UNI EN 12165 body, nickel-plated on the external surface
- 8 PTFE gasket
- 9 CW617N UNI EN 12165 chrome-plated ball
- 10 CW617N UNI EN 12165 end adaptor, nickel-plated on the external surface
- 11 For 1/2" and 3/4" versions extension made of plastic sleeve PA6 loaded 50% glass fibre, for 1" to 2" versions of nickel-plated CW617N UNI EN 12165



**Mit Aluminium-Hebel**  
With aluminium lever

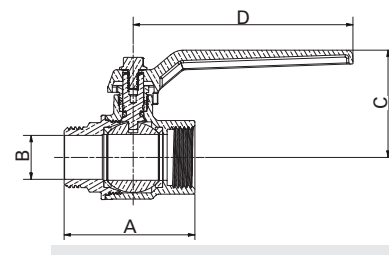

Anschlüsse Connections	Produktcode Product code	PN	A ±1mm	B mm	C mm	D mm	VE klein/groß* Pack. num. pieces*	
3/8"	302C38G5R	302C38G5B	25	48	11	41	95	-
1/2"	302D12G5R	302D12G5B	25	51	15	43	95	-
3/4"	302E34G5R	302E34G5B	25	56,5	20	46,3	95	-
1"	302F001G5R	302F001G5B	25	68,5	25	61,5	115	-
1" 1/4	302G114G5R	302G114G5B	25	77,5	32	66,7	115	-
1" 1/2	302H112G5R	302H112G5B	25	86,5	40	80,2	165	-
2"	302I002G5R	302I002G5B	25	113,6	50	88,7	165	-

\* Bitte kontaktieren Sie das Unternehmen für Informationen über Verpackung und Mengen.  
\* For details on packaging and quantities, please contact the company.



**Mit Hebel aus tiefgezogenem Stahl**  
With drawn steel lever

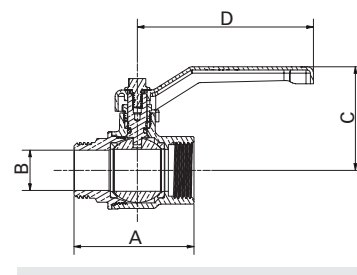



Anschlüsse Connections	Produktcode Product code	PN	A ±1mm	B mm	C mm	D mm	VE klein/groß Pack. num. pieces	
3/8"	302C38G1R	302C38G1B	25	48	11	44	83	12/144
1/2"	302D12G1R	302D12G1B	25	51	15	45	83	10/120
3/4"	302E34G1R	302E34G1B	25	56,5	20	48	83	8/96
1"	302F001G1R	302F001G1B	25	68,5	25	68	90	4/48
1" 1/4	302G114G1R	302G114G1B	25	77,5	32	73	90	15
1" 1/2	302H112G1R	302H112G1B	25	86,5	40	78	160	10
2"	302I002G1R	302I002G1B	25	113,6	50	90	160	10

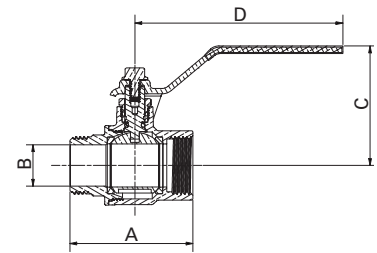

**Mit Flachhebel aus Edelstahl AISI 304**  
 With AISI 304 stainless steel flat lever





Anschlüsse Connections	Produktcode Product code	PN	A ±1mm	B mm	C mm	D mm	VE klein/groß Pack. num. pieces
	 						
3/8"	302C38G4R      302C38G4B	25	48	11	41	95	12/144
1/2"	302D12G4R      302D12G4B	25	51	15	43,1	95	12/144
3/4"	302E34G4R      302E34G4B	25	56,5	20	46,3	95	8/96
1"	302F001G4R      302F001G4B	25	68,5	25	59,6	115	3/36
1" 1/4	302G114G4R      302G114G4B	25	77,5	32	64,7	115	15
1" 1/2	302H112G4R      302H112G4B	25	86,5	40	77,7	165	10
2"	302I002G4R      302I002G4B	25	113,6	50	85,7	165	10

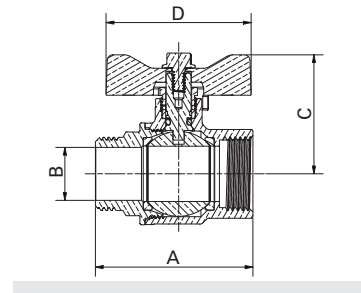

**Mit Aluminium-T-Griff**  
With aluminium "T" handle

 **TRINKWASSER**  
DRINKING WATER





Anschlüsse Connections	Produktcode Product code	PN	A ±1mm	B mm	C mm	D mm	VE klein/groß Pack. num. pieces
 							
3/8"	302C38G6R    302C38G6B	25	48	11	37,5	52	12/144
1/2"	302D12G6R    302D12G6B	25	51	15	39,5	52	10/120
3/4"	302E34G6R    302E34G6B	25	56,5	20	42,5	52	8/96
1"	302F001G6R    302F001G6B	25	68,5	25	50,5	65	4/48
1" 1/4"	302G114G6R    302G114G6B	25	77,5	32	55,7	65	15

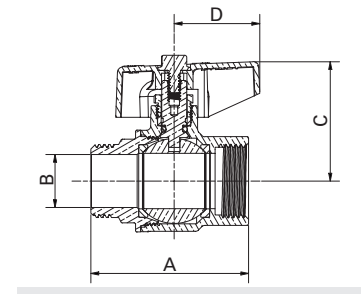

**Mit Drehknopf aus Aluminium**  
With aluminium knob

 **TRINKWASSER**  
DRINKING WATER



Anschlüsse Connections	Produktcode Product code	PN	A ±1mm	B mm	C mm	D mm	VE klein/groß Pack. num. pieces
 							
3/8"	302C38G2R    302C38G2B	25	48	11	36	31,5	12/144
1/2"	302D12G2R    302D12G2B	25	51	15	39,5	31,5	10/120
3/4"	302E34G2R    302E34G2B	25	56,5	20	42,8	31,5	8/96
1"	302F001G2R    302F001G2B	25	68,5	25	53	42,5	4/48
1" 1/4"	302G114G2R    302G114G2B	25	77,5	32	58,5	42,5	15





## Mit Verlängerung und Aluminium-Hebel With extension stem and aluminium lever

Für Versionen 1/2" und 3/4", Verlängerungshülse aus Kunststoff PA6, 50% glasfaserverstärkt, für die Ausführungen von 1" bis 2" aus vernickeltem CW617N UNI EN 12165.

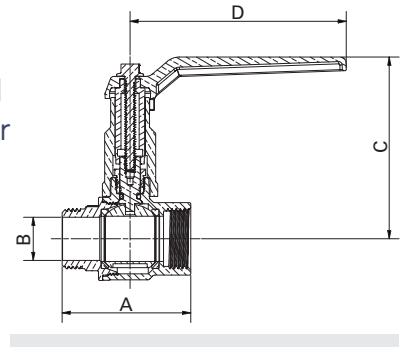
For 1/2" and 3/4" versions extension made of plastic sleeve PA6 loaded 50% glass fibre, for 1" to 2" versions of nickel-plated CW617N UNI EN 12165



Anschlüsse Connections	Produktcode Product code	PN	A ±1mm	B mm	C mm	D mm	VE klein/groß* Pack. num. pieces*	
								
1/2"	302D12G5RFM	302D12G5BFM	25	51	15	76,6	95	-
3/4"	302E34G5RF	302E34G5BF	25	56,5	20	79,9	95	-
1"	302F001G5RF	302F001G5BF	25	68,5	25	99	115	-
1" 1/4	302G114G5RF	302G114G5BF	25	77,5	32	104	115	-
1" 1/2	302H112G5RF	302H112G5BF	25	86,5	40	132,7	165	-
2"	302I002G5RF	302I002G5BF	25	113,6	50	140,7	165	-

\* Bitte kontaktieren Sie das Unternehmen für Informationen über Verpackung und Mengen.

\* For details on packaging and quantities, please contact the company.





## Mit Verlängerung und Hebel aus tiefgezogenem Stahl With extension stem and drawn steel lever

Für Versionen 1/2" und 3/4", Verlängerungshülse aus Kunststoff PA6, 50% glasfaserverstärkt, für die Ausführungen von 1" bis 2" aus vernickeltem CW617N UNI EN 12165.

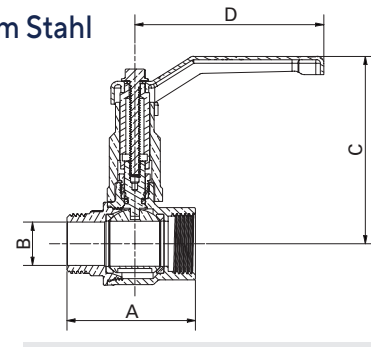
For 1/2" and 3/4" versions extension made of plastic sleeve PA6 loaded 50% glass fibre, for 1" to 2" versions of nickel-plated CW617N UNI EN 12165



Anschlüsse Connections	Produktcode Product code	PN	A ±1mm	B mm	C mm	D mm	VE klein/groß Pack. num. pieces	
								
1/2"	302D12G1RFM	302D12G1BFM	25	51	15	79	83	40
3/4"	302E34G1RF	302E34G1BF	25	56,5	20	82,3	83	30
1"	302F001G1RF	302F001G1BF	25	68,5	25	104,1	90	30
1" 1/4	302G114G1RF	302G114G1BF	25	77,5	32	109,2	90	20
1" 1/2	302H112G1RF	302H112G1BF	25	86,5	40	135,2	160	16
2"	302I002G1RF	302I002G1BF	25	113,6	50	143,2	160	10





**Mit Verlängerung und Aluminium-T-Griff**  
With extension stem and aluminium "T" handle

Für Versionen 1/2" und 3/4", Verlängerungshülse aus Kunststoff PA6, 50% glasfaserverstärkt, für die Ausführungen von 1" bis 1" 1/4 aus vernickeltem CW617N UNI EN 12165.

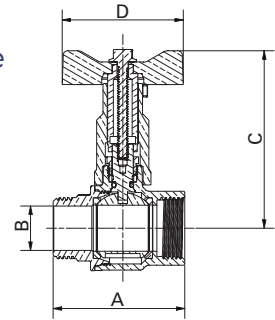
For 1/2" and 3/4" versions extension made of plastic sleeve PA6 loaded 50% glass fibre, for 1" to 1" 1/4 versions of nickel-plated CW617N UNI EN 12165



Anschlüsse Connections	Produktcode Product code	PN	A ±1mm	B mm	C mm	D mm	VE klein/groß Pack. num. pieces
	 						
1/2"	302D12G6RFM    302D12G6BFM	25	51	15	72,9	52	40
3/4"	302E34G6RF    302E34G6BF	25	56,5	20	76,2	52	30
1"	302F001G6RF    302F001G6BF	25	68,5	25	88	65	30
1" 1/4"	302G114G6RF    302G114G6BF	25	77,5	32	93	65	20





**Mit Verlängerung und Aluminium-Drehknopf**  
With extension stem and aluminium knob

Für Versionen 1/2" und 3/4", Verlängerungshülse aus Kunststoff PA6, 50% glasfaserverstärkt, für die Ausführungen von 1" bis 1" 1/4 aus vernickeltem CW617N UNI EN 12165.

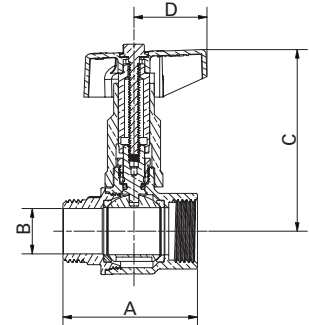
For 1/2" and 3/4" versions extension made of plastic sleeve PA6 loaded 50% glass fibre, for 1" to 1" 1/4 versions of nickel-plated CW617N UNI EN 12165



Anschlüsse Connections	Produktcode Product code	PN	A ±1mm	B mm	C mm	D mm	VE klein/groß Pack. num. pieces
	 						
1/2"	302D12G2RFM    302D12G2BFM	25	51	15	73	31,5	40
3/4"	302E34G2RF    302E34G2BF	25	56,5	20	76,3	31,5	30
1"	302F001G2RF    302F001G2BF	25	68,5	25	90,2	42,5	30
1" 1/4"	302G114G2RF    302G114G2BF	25	77,5	32	95,3	42,5	20